

RETAIL PACKAGED PRODUCTS

Kinedyne is a leader in the development of packaging and display solutions for various retail environments. Our cargo securement offering includes many items with packaging specifically designed to draw attention to our products in retail stores and on showroom displays.

SHIP & DISPLAY CASE

A stylish and rugged master carton designed as a shipping carton with tear away front panel. Case can be used in showrooms and on shelf displays. See page 107 for strap specifications.

15531-1BX – 1" Utility Strap with Ratchet Buckle. Box Qty. (40 pcs.)



BLISTER PACKAGING – STRAP ASSEMBLIES

Strap assemblies available in Four Pack in this packaging is very popular in retail channels.

Four-Pack Sets

One-Inch Straps with Vinyl Coated S-Hooks

See page 107 for details on 15531-1 and 15532-1 Strap Assemblies

Working Load Limit per strap: 500 lbs./230 kgs.



15531

Pack includes strap assembly 15531-1 with Ratchet Buckle and 12' Web x Four straps.



15532

Pack includes strap assembly 15532-1 with Cam Buckle and 6' Web x Four straps.

POLY BAG & HEADER CARD

Many of our one-inch strap assemblies are packaged in convenient poly bag with a header card making them suitable for hook style display racks. See page 25 for a sampling of our "PK" series straps packaged in this manner.



MERCHANDISABLE BOXES

Several products are packaged in full color boxes suitable for shelf displays. The boxes are designed to draw buyers to the product with graphics, photographs and operating instructions. The Cargo Bar is ideal for use in automobiles and pick up trucks to keep cargo from shifting. The Cargo Bar is a steel and adjusts from 40" to 70".

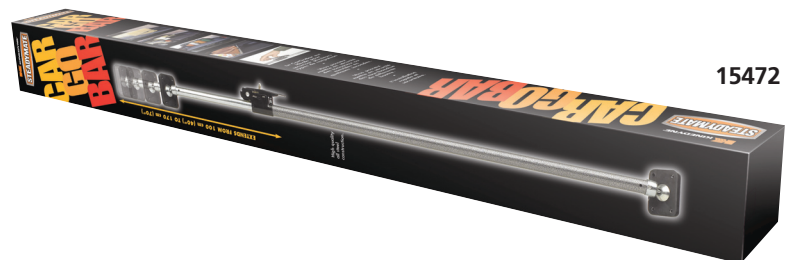

15472



TYING DOWN YOUR OUTDOOR ADVENTURE TOYS

JUST HOW STRONG ARE OUR TIE-DOWNS? As strong as you need.

	WEB SIZE X LENGTH	WORKING LOAD LIMIT lbs. / kgs.	TENSIONING DEVICE	HOOK	BUILT-IN SOFT LOOP	POSITIVE LOCK HOOK
1	1" x 5'	835/380	CAM	VINYL		
2	1" x 5'	835/380	RATCHET	VINYL		
3	1" x 6'	835/380	CAM	RUST PROOFED*	✓	
4	1" x 6'	835/380	CAM	RUST PROOFED*	✓	✓
5	1" x 6'	1000/455	RATCHET	RUST PROOFED*	✓	✓
6	2" x 6'	1670/757	RATCHET	RUST PROOFED*	✓	✓

* E coated

North Americans love their recreational vehicles! Motorcycles, ATVs, personal watercrafts, boats, snowmobiles, pick-up trucks, camping gear and bicycles are their adventure toys of choice, and they care about them. We've responded to this growing market by creating Steadymate™ – a complete recreational vehicle securement system that delivers legendary Kinedyne® quality.

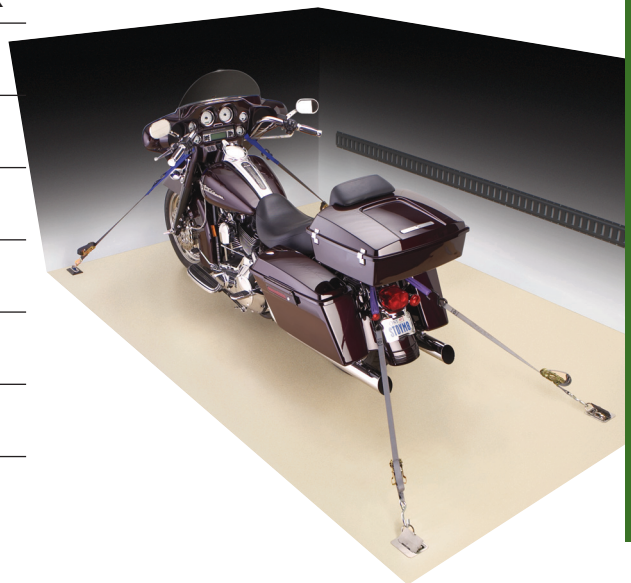

ACCESSORIES

Handle Strap (2 per package)

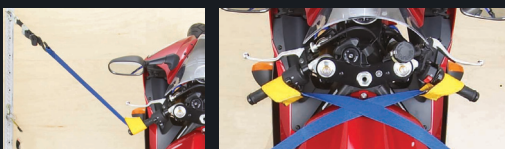

15427

The Handle Strap is designed to fit over the handle of your vehicle and secure to either the Cinchtite 1 and 2 tie-down series.

Working Load Limit: 500 lbs. / 230 kgs.

Soft Loop (2 per package)



15471

BASKET

CHOKER

The 18" Soft Loop is designed to work with any type of tie-down that you are using (specifically the Cinchtite 1 and 2).

Working Load Limit: 1,000 lbs. / 455 kgs.

Kwik Strap (2 per package)



15508

BASKET

CHOKER

Similar in function to the Soft Loop this premium accessory is made with round sling material to add a "little give" over the rougher terrain.

Working Load Limit: 1,000 lbs. / 455 kgs.

Fleecemate (2 per package)



15657

Use with Cinchtite tie-downs, Handle Straps and Soft Loops to protect vehicle finish as well as to prolong the life of the strap.



WEBBING

See chart on previous page for Cinchtite comparison at a glance.

CINCHTITE® 1 WORKING LOAD LIMIT 835 lbs./380 kgs.

- Zinc plated, corrosion resistant S Hook.
- Aircraft cam buckle allows fast and efficient locking with easy-to-use press and release.
- Vinyl coated, scratch resistant S Hook.

CINCHTITE® 2 WORKING LOAD LIMIT 835 lbs./380 kgs.

- Zinc plated, corrosion resistant S Hook.
- Easy-to-use quick tightening ratchet buckle and one-hand release bar.
- Vinyl coated, scratch resistant S Hook.

CINCHTITE® 3 WORKING LOAD LIMIT 835 lbs./380 kgs.

- Aircraft cam buckle allows fast and efficient locking with easy-to-use press and release.
- Built in Soft Loop to protect your paint and chrome.
- Shock absorbing sling type material
- E coated, scratch resistant S Hook.

CINCHTITE® 4 WORKING LOAD LIMIT 835 lbs./380 kgs.

- Positive Lock Military Snap Hook, to prevent release over rough terrain.
- Aircraft cam buckle allows fast and efficient locking with easy-to-use press and release.
- Built in Soft Loop to protect your paint.
- Shock absorbing sling type material.
- E coated, scratch resistant S Hook.

CINCHTITE® 5 WORKING LOAD LIMIT 1,000 lbs./455 kgs.

- Positive Lock Military Snap Hook, to prevent release over rough terrain.
- Easy-to-use quick tightening ratchet buckle and one-hand release bar.
- Built in Soft Loop to protect your paint and chrome.
- Shock absorbing sling type material
- E coated, scratch resistant S Hook.

CINCHTITE® 6 WORKING LOAD LIMIT 1,670 lbs./757 kgs.

- Positive Lock Military Snap Hook, to prevent release over rough terrain
- Easy-to-use quick tightening ratchet buckle and one-hand release bar.
- Built in Soft Loop to protect your paint and chrome.
- E coated, scratch resistant S Hook.
- Designed with 2" webbing and engineered for the trucking industry.

AND HARDWARE BEYOND COMPLIANT!

THERE'S A STEADYMATE CINCHTITE TIE-DOWN FOR ANY MOTORCYCLE, SNOWMOBILE, ATV OR PERSONAL WATERCRAFT

For securement point kits and fittings, please see page 88.

All Cinchtite tie-downs come 2 in a box, with full instructions – and remember, you'll need 4 tie-downs to properly secure your vehicle.

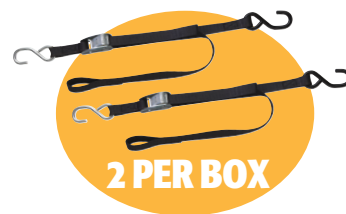

15464

1" x 5' Tie-Down



15465

1" x 5' Tie-Down

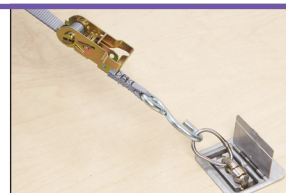

15466

1" x 6' Tie-Down

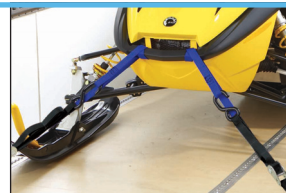

15468

1" x 6' Tie-Down

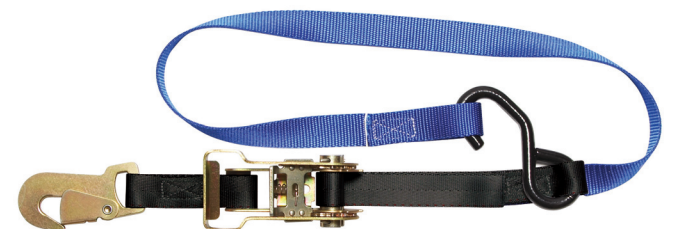

15469

1" x 6' Tie-Down



15470

2" x 6' Tie-Down



PRODUITS POUR VÉHICULES RÉCRÉATIFS • PRODUCTOS PARA VEHÍCULOS DE RECREACIÓN

ACCESSORIES

NOTE: Before you secure your stern with one of Steadymate's Transom Trappers, ensure that the bow of your boat is secure on the trailer winch in the lock position by using another of Steadymate's Tie-Downs.

Boat Bow Safety Strap 15534



Ensure your boat doesn't bounce off your Bow Rollers by using this preventative Bow Strap.

Working Load Limit:
835 lbs./380 kgs.



Personal Watercraft Strap 15535

Created with flexibility in mind. Designed to easily adapt to any make or size of personal water craft for securing to your trailer.

Working Load Limit:
835 lbs./380 kgs.



Boat Winch Strap 15622

This winch strap is made from resin-coated polyester for minimum stretch and maximum wear resistance. With a 2" Snap Hook it is a rugged strap that provides the strength and durability demanded in a boat trailer tie-down requirement.

Working Load Limit: 1,670 lbs./757 kgs



Gunwale Strap 15536/15536R

This strap was designed with the outdoorsman in mind. Easy to use and fast to install, this tie-down goes over your boat from one side of the trailer to the other.

15536 – Cam Buckle (shown)

15536R – Ratchet Buckle.

Working Load Limit:
835 lbs./380 kgs.

1" x 14' length fully extended



MARINE

Steadymate's Transom Trapper's have been designed with more than just quality and ease of use in mind.

TRANSOM TRAPPER® I

- Extra long, 3 inch wide gel coat protector prevents scratches from overcenter buckle and hook end.
- Aircraft cam buckle allows fast and efficient locking with easy to use press and release.
- Built in velcro guide ensures gel coat protector does not shift and allows storage of excess web.
- DOT Regulation Compliant, positive locking 1" zinc plated military hook end.
- DOT Regulation Compliant Tags.

TRANSOM TRAPPER® II

- Extra long, 3 inch wide gel coat protector prevents scratches from overcenter buckle and hook end.
- Overcenter buckle provides additional tension due to a toggle tightening action. This mechanism will not disengage unless manually released.
- DOT Regulation Compliant, positive locking 2" zinc plated military hook end.
- DOT Regulation Compliant Tags.

TRANSOM TRAPPER® III

OUR PREMIUM MARINE TIE-DOWN

- Built in velcro guide ensures gel coat protector does not shift and allows storage of excess web.
- DOT Regulation Compliant, positive locking 2" zinc plated military hook end.
- 2" zinc plated extra wide handled ratchet allows cargo type tensioning, just like the big trucks!
- Extra long 4" wide gel coat protector prevents scratches from ratchet and hook end.
- DOT Regulation Compliant positive locking 2" twisted zinc plated military hook will not come loose from the trailer while in transit.

Why Twisted?

In "Big" boat applications it evenly distributes the load over the trailer's welded "U" hooks without the strap twisting. This strap is good for both stern and freeboard applications.

- DOT Regulation Compliant Tags.

SAFETY IN TRANSIT IS JUST AS IMPORTANT AS SAFETY ON THE WATER



PRODUITS POUR VÉHICULES RÉCRÉATIFS • PRODUCTOS PARA VEHÍCULOS DE RECREACIÓN

15474 Working Load Limit: 835 lbs./378 kgs
Length range from 12" - 54"



15475 Working Load Limit: 1,330 lbs./603 kgs
Length range from 18" - 60"



15529 Working Load Limit: 3,335 lbs./1,512 kgs
Length range from 22" - 144"



WHEEL CHOCK

80014

This heavy duty chock assembles easily in about 15 minutes...and keeps your bike supported straight up (no kick stand required) making one-person operation fast and simple.

It's perfect for scooters, mopeds, dirt bikes, sport bikes, cruisers and chopper-style motorcycles.



SNOW AND MUD ARE NO MATCH FOR OUR #1 SELLING TOW STRAP

Snowmobile/ATV Tow Strap

15543

Whether stuck in slush, deep powder or mud ensure you are prepared. This rescue strap should be part of every snowmobiler's and four wheeler's tool kit. Durable 1 inch web is 15' long and has snap hook ends so it does not come loose during use.

(Working load limit 835 lbs./380 kgs.)



Versatile soft loop designed to protect paint and chrome.

Spring loaded snap hook locks into steel "D" ring for guaranteed safety.

REMEMBER... IT'S ONLY AS STRONG AS THE WEAKEST LINK

A PREMIUM STRAP DESERVES A RELIABLE SECUREMENT POINT.

SECUREMENT POINT KIT

15526



Surface Mount E Kit

The Surface Mount E Kit can be easily installed without any routing. It is an easy bolt-on solution to creating a securement point anywhere in your trailer. Once installed, logistic straps, tie-offs and wire hook tie-downs can be used for securing. This is a great solution for two bikes or sleds sharing the same fitting in a double wide trailer.

Includes 1 Tie-Off (660001-2PK) and installation hardware.

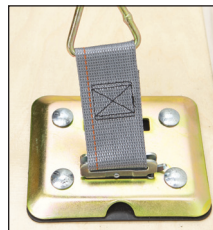

Combined with the included tie-off, this kit is easy and convenient...



...simply snap it into place and attach any Steadymate strap.

All securement point kits and track kits come complete with full installation instructions.

PAN FITTINGS

2 PER PACKAGE

Pan fittings can be used with any of the Cinchtite series tie-down straps, or other utility straps, rope or chain. Typically pan fittings are mounted in the walls or floors of trucks or trailers.

Recessed Mount (2 per package)



32210-2PK

The Recessed Mount Pan Fitting is a seamless flush fitting that requires a router or hole saw for installation. In order to endure the North American climate they have a gold chromate finish.

Working load limit:
835 lbs./380 kgs.

Recessed Mount Heavy Duty (2 per package)



7196-2PK

These Heavy Duty Pan Fittings are zinc plated and recessed for a flush surface.

Working load limit:
1,667 lbs./756 kgs.



TRAILER SECUREMENT POINTS

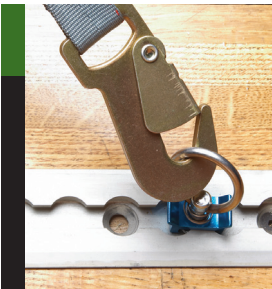

TRACK KITS

Track options that are used in the airline industry to secure seats, are available for securing your recreational vehicle. Unlike the fixed point of a pan or floor fitting, Steadymate's 8" L Track Kits allow for more flexibility. Loading your motorcycle, ATV, or snowmobile on your trailer in exactly the same position each time is difficult. The track solution and Stud Fitting provides 8"-16" of front to back adjustment (see diagram below). The larger footprint makes your trailer more universal (Motorcycle in the summer, ATV in the fall).

Surface Mount L Track Kit



15522 – Aluminum

The Surface Mount L Track Kit is an easy install solution for either the floor or wall of your trailer. Comes with one 8" piece of track, Steadymate Stud Fitting (32401) and installation hardware.

Recessed Mount L Track Kit



15523 – Aluminum

The Recessed L Track Kit is a seamless flush fit for either the floor or wall of your trailer. Comes with one 8" piece of track, Steadymate's Stud Fitting (32401) and installation hardware.

8" – 16" of flexibility.

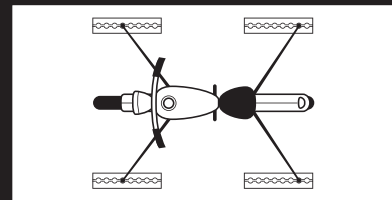

SERIES L ALUMINUM TRACKS

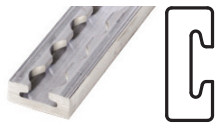

15544

Same track as in the 15522 surface mount kit shown at the top of this page. Track is available in 100 inch lengths for those who want full trailer tie down capabilities. Pre-drilled and countersunk every 4 inches for easy installation.



15545

Same track as in the 15523 recessed mount kit shown at the top of this page. Pre-drilled and counter sunk every 4 inches and is available in 100 inch lengths.

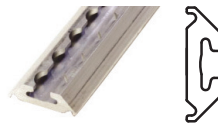

15546

Angled profile of this surface mount track gives you an unobstructed floor to allow ease in the loading and unloading of your recreational vehicle. Track length is 100 inches and is pre-drilled and countersunk every 4 inches.

SERIES E TRACKS



15547 – Galvanized

15548 – Powder Coated

High strength 12 gauge steel. Available in 10 foot lengths.

With our popular E Track mounted in the floor or on the wall of your trailer, you will have the flexibility to add more tie down points and peace of mind when securing your cargo.

ACCESSORIES AND FITTINGS



32401-2PK

Steadymate's Stud Fitting (L Series)

90° Horizontal Pull
WLL:
1,000 lbs./455 kgs.



32507-2PK

Heavy Duty Triple Stud Fitting with Pear Ring (L Series)

90° Horizontal Pull
Angle WLL:
1,667 lbs./760 kgs.



FE8301-1-2PK

Series E or A Fitting with 2" D-ring

WLL:
2,000 lbs./910 kgs.



FE8264-1-2PK

Series E or A Fitting with 1" D-ring

WLL:
2,000 lbs./910 kgs.



80023-2PK

E-Key Fitting for Decking Beam

Keyhole Slot
WLL:
335 lbs./151 kgs.



660001-2PK

Tie-Off 2" Web 6" Length

WLL:
1,000 lbs./455 kgs.



8663-4PK

Recessed L Track End Cap



8730-4PK

End Cap E/A Track



FE200751-1PK

Filler Strip for L Track. Available in 25' rolls.

⚠ WARNING: Only trained, knowledgeable personnel should use tie down straps. It is operator's responsibility to use appropriate type and number of straps for the load being secured. Webbing straps must be protected when used on rough or sharp objects. Straps that are cut, worn or damaged shall not be used and shall be replaced immediately. All strap assemblies shall be inspected prior to each use. The use of "Cheater bars" or other means of increasing leverage on a ratchet buckle handle or winch, other than a Kinedyne approved device, can cause serious injury to the user and/or bystander. Webbing straps are rated for use in temperature range from +194 degrees F (+90°C) to -40 degrees F (-40°C). Straps should be stored out of direct sun and away from damaging chemicals when not in use. Ensure load is stable before tightening or releasing tension in a strap assembly.



15531
Four Pack of Utility Straps
Ratchet Buckle with 12' Web

Econopack designed to give you 4 utility straps in one package. These light duty 1" ratchet tensioning straps are ideal for securing loads, bicycles, boxes or any other item that you want to ensure doesn't move.



Straps come complete with vinyl coated S Hooks.

Set includes 4 pcs. of #15531-1 Utility Strap Assembly x 12 feet with 1" web and Ratchet Buckle.

Working Load Limit: 500 lbs./230 kgs.



15532
Four Pack of Utility Straps
Cam Buckle with 6' Web

Econopack designed to give you 4 utility straps in one package. These light duty 1" cam tensioning straps are ideal for securing loads, bicycles, boxes or any other item that you want to ensure doesn't move.



Straps come complete with vinyl coated S Hooks.

Set includes 4 pcs. of #15532-1 Utility Strap Assembly x 6 feet with 1" web and Cam Buckle.

Working Load Limit: 400 lbs./185 kgs.

ENHANCE YOUR SECUREMENT WITH THESE HANDY
STEADYMATE PRODUCTS

⚠ WARNING: Tree Saver is not to be used for lifting or towing.



Vinyl Ratchet Cover
9064-1PK

The Vinyl Ratchet Cover is designed to prevent abrasion and scratching caused by the metal edges of a ratchet's vibration while in transit. It is made from durable black vinyl, and is held in place around 1" or 2" ratchets with velcro edging.

Strap Bag
80017

Most utility trailers offer little to no storage. The Strap Bag, designed for E Track and E Kits, can be used for all your accessories and Tie-Down straps. Bag size 14" high x 24" wide



Tree Saver
15461

The 6' Tree Saver was developed to ensure you protect Mother Nature from damage caused by cable and chain and to keep tree sap from your expensive Rope or Tie-Down.

Webbing Size: 6' long, 4" wide

Working Load Limit:
Basket: 11,000 lbs./5000 kgs.
Choker: 5,280 lbs./2395 kgs.

